

PROJECTION AXIS

STAGE ELEVATOR

EXTENSION PART OF FLYBAR REAR STAGE

Maximum extension 50cm



Load of the fully extended ext. part: G max = 50 kg

EXTENSION PART OF FLYBAR

Maximum extension 50cm

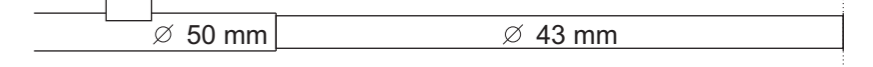

Load of the fully extended ext. part: G max = 50 kg

Decoration (maximum transportation dimensions)

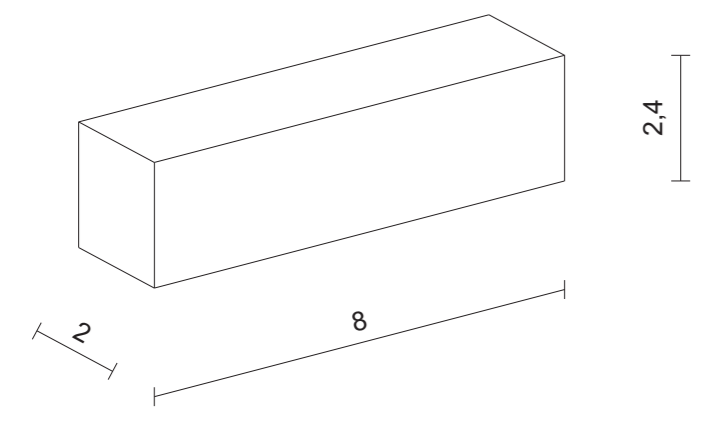

Insertion on the stage

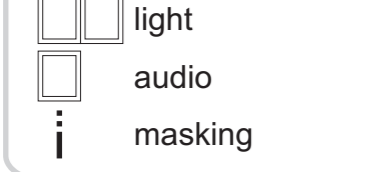

POINT HOIST

Quantity: 10 ks
Load: 600 kg
Symbol: +

FLYBARS-MOTOR

max. 160 kg

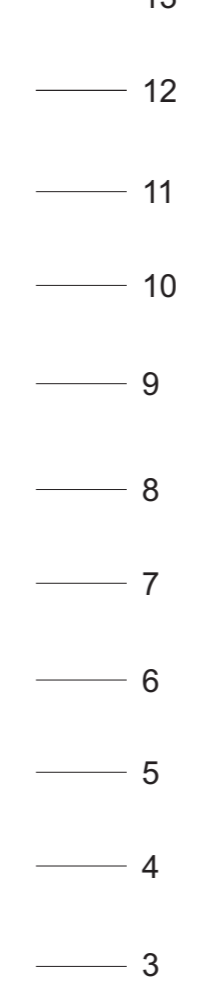

TABLES (max. load of tables 500 kg/m² static, 100 kg/m² dynamic)

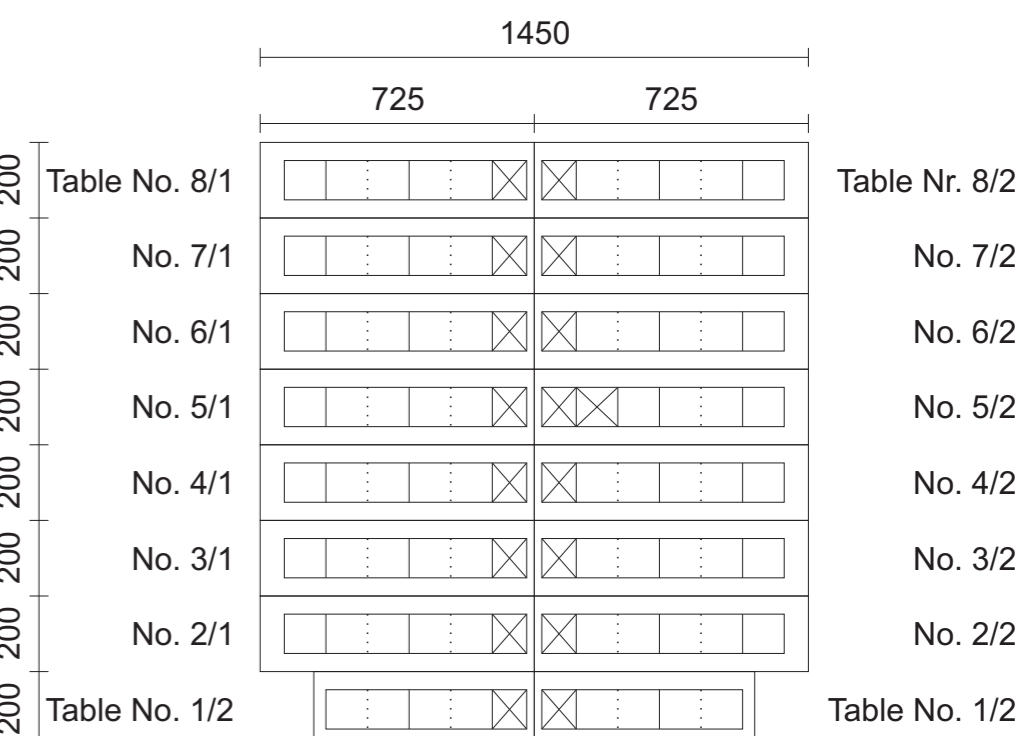

The dotted braces are possible to take away
Traps, where the trap mechanism is not possible to be installed
Traps: 1,1 x 1 m

FLYBARS - MANUAL

max. 250 kg

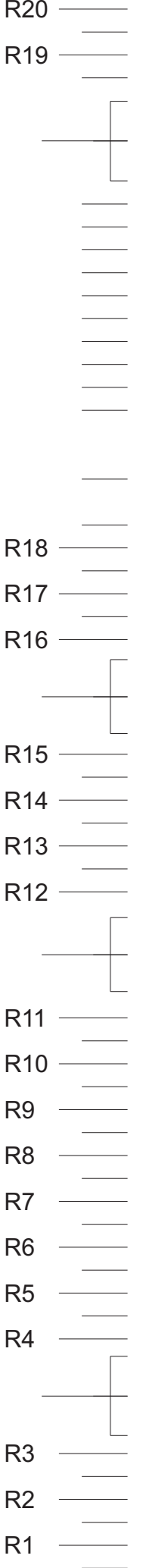

Back masking

FLYBARS - MOTOR

(max. 650 kg)

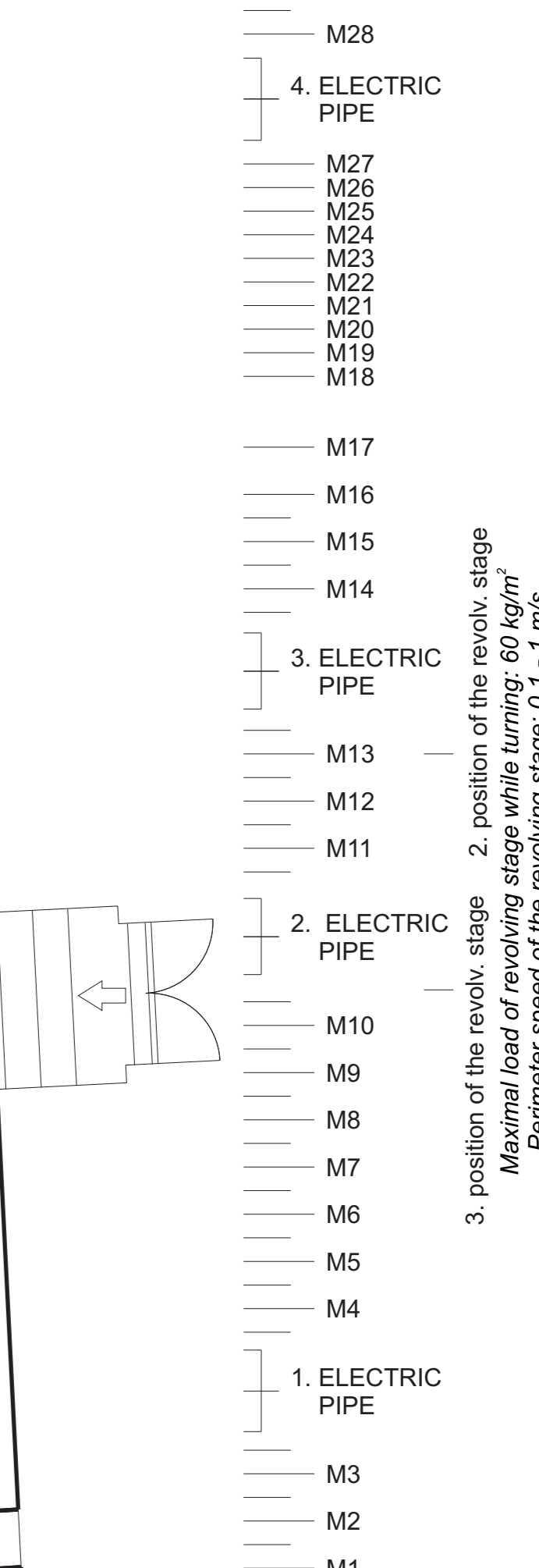

3. position of the revolv. stage
Maximal load of revolving stage while turning: 60 kg/m²
Perimeter speed of the revolving stage: 0,1 - 1 m/s
Diameter of the revolving stage: 14 m

PORTAL FLYBAR
GAUZE
MAIN CURTAIN
CEREMONIAL CURTAIN
IRON CURTAIN
OPENING OF THE PROMPTER'S BOX

Národní divadlo

top view 1:50

AUTHOR		DRAWN
PLAY		
DIRECTOR		
ART DIR.		
OPER. ARCH.		
DRAWING		stage v3.0 Filip HAVLICEK